

Article number: 390204901812736

Description: Worm Gear with Torque Limiter
VF 49-L2-N-18 P71B5

Measures

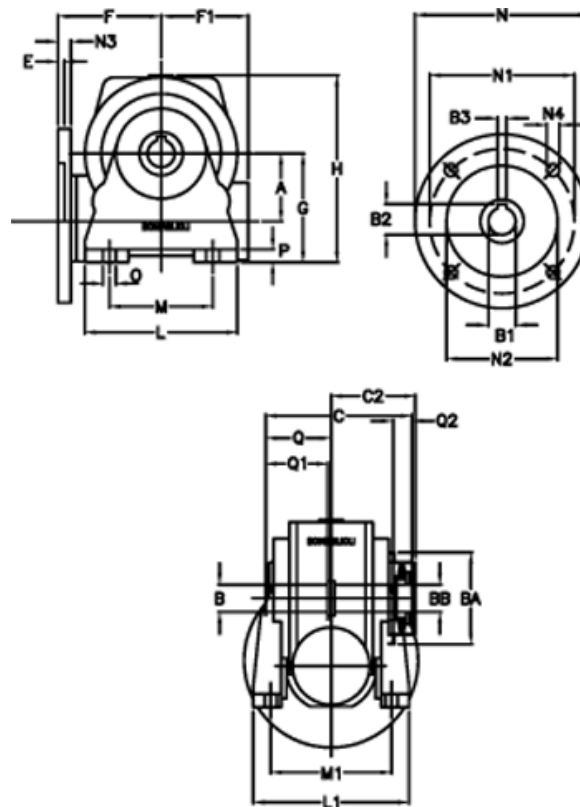

a = 49.50	C2 = 63,5	L1 = 124	O = 8.5
B = 25	Description = VF 49N-xx-71B5	m = 63	P = 12
B1 E7 = 14	E = 3.0	M1 = 98.5	Q = 51.0
B2 = 16.3	F = 70	N = 160	Q1 = 41
B3 H9 = 5	F1 = 63	N1 = 130	Q2 = 15
BA = 63	g = 82	N2 = 110	
BB H7 = 14	H = 138.0	N3 = 10.5	
C = 105	L = 110	N4 = 9,5	